

TH-2401 Multifunctional Folding Bedside Tray Table

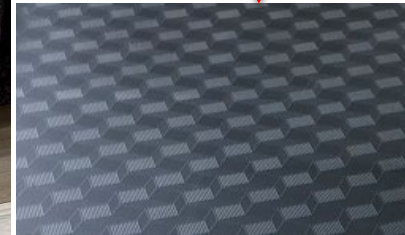

Durable metal legs, 2-way adjustable heights (25 or 20 cm)

With anti-slip texture



Top size 34*22 cm
Material: high impact ABS+ thicker metal steel leg

Save space, when the aisle is too narrow, fold it down, then you can go through.

折下來多出走道空間



TH-2401 Multifunctional Folding Bedside Tray Table

Load weight
3 kgs



Thicker strong
iron steel legs,
no tool need.

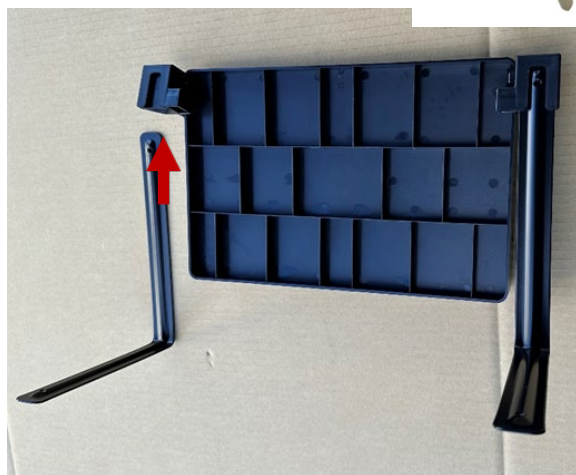

TM-111 Movable Sofa Side Table, Coffee, Dining Table, Storage, Corner Table Snack End Table, Slide Under Sofa with Rolling Casters



Slide easily under a sofa or bed. Lean against the sofa side to save space, and bring the table's surface closer to you.



Keep everything within reach by using this table as a couch table for remotes, a TV tray table for snacks, a bedside nightstand, a laptop table, or a breakfast desk, coffee table.

TM-111 Movable Sofa Side Table, Coffee, Dining Table, Storage, Corner Table Snack End Table, Slide Under Sofa with Rolling Casters



K/D ship with small package
volume less than 1CU'FT.
Weight.: 5.2 KGS

This modern side table's simplistic style and versatility are perfect as a workspace or additional surface area for your living room, lounge area, or office space.

Durable steel legs and high impact ABS top with anti-slip texture.

Set up size 51.7x42x69 cm

- 1) One standard combo set Include 1 shelf, 1 pegboard, 2 boxes, 3 hooks, Consumers can order extra boxes/hooks accessories, if not enough
- 2) With high density holes, the pegboard is better than the metal pegboard, one pegboard can be used two sides to hang things.

TH-23006SH Keep it Organized Strong Pegboard
 fix to the shelving unit by velcro strap
 高強度洞洞板 (用魔鬼氈束帶固定到層板)



The velcro strap at the backside's position is adjustable to fit different shelving unit rack's dimensions

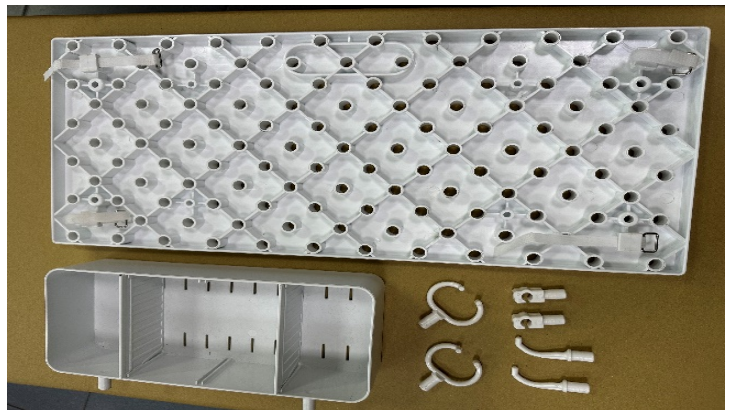

免鑽孔，容易安裝，容易整理
 * Drill free. * Easy to install. * Easy to c

1 set include 1 box+6 hooks,if not enough, you can order more accessories

can put 3 or more pegboards together to be bigger pegboard, please see below pictures

Hanging Hook Accessories 掛鉤配件

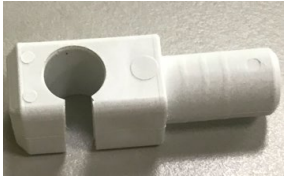

Screwdriver hook

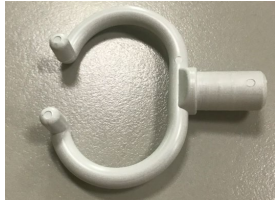

C hook



I hook

3 kinds of hanging hook



box with 3 partition plates



the partition plates are removable

230 G 26.7x11.5x6.2 cm

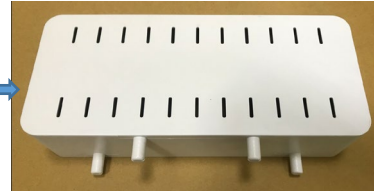

box can be turned upside down to be a platform

can put 3 or more pegboards together to be bigger pegboard

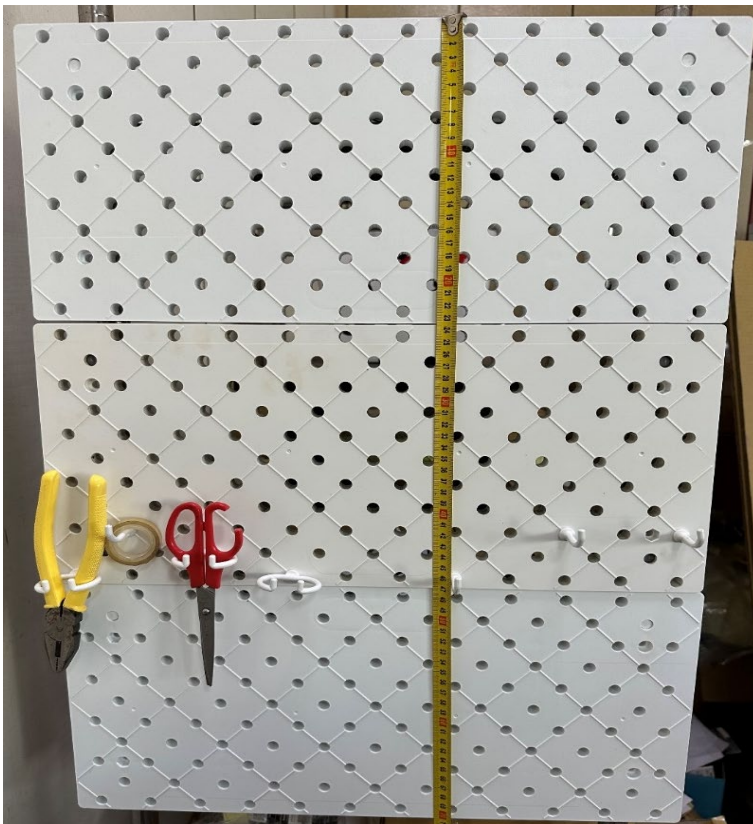

One Pegboard 650 g

51.7x23.5x1.8 cm

It also can stick or screw to the wall
Please see images at next page

It also can stick or screw to the wall

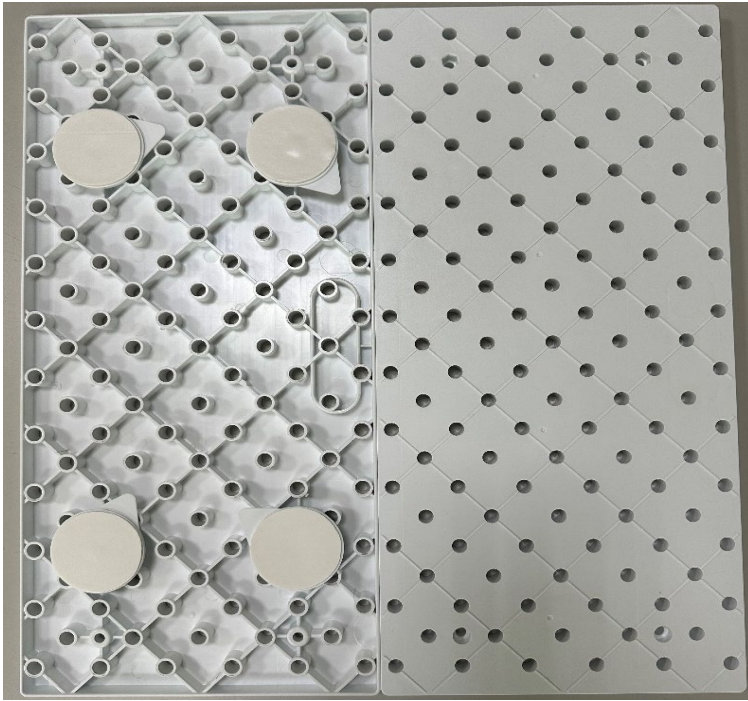

Back

Front

Pegboard for wall with tape and screw

壁粘或壁鎖洞洞板



Pegboard 650 g

51.7x23.5x1.8 cm



EASY TO INSTALL/
NO TOOLS REQUIRED

Space
Saver

FULLY
ADJUSTABLE

8.2"
(20.8 CM)

18.75"
(47.6 CM)

NON-SLIP
GRIPS



HOLDS UP TO
10 KGS 22 LBS

TH-2101 **PATENT** BIG Shelf for all kinds of windowsill, computer /TV screen, office partitions/ divider wall 專利加大各式窗戶及電視電腦螢幕/ 辦公室隔間牆 置物架



2個並べて、さらにスペースを拡張

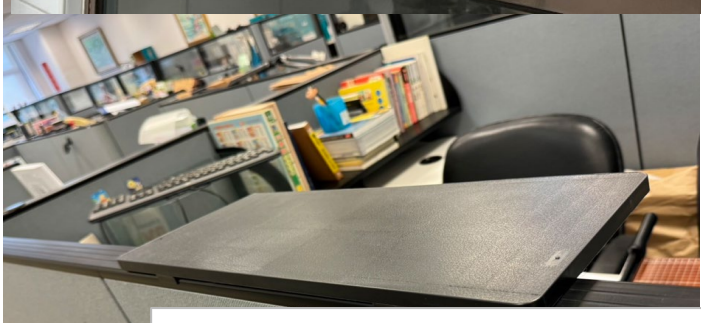

段差がないから
長いものも置ける!

Heavy Duty good for office partitions/ dividers wall 高耐重適合辦公室隔間牆

use two for bigger space
大空間 可兩個並用

Easy install and adjust the angle
without tool免工具安裝 角度易調

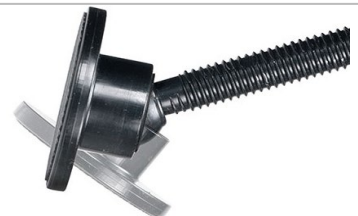

TH-2206 | Low Price Convenient Strong Ladder Chair

- Chair and Ladder two in one with very strong strength.
- Material is strong plastic + iron steel with competitive price, the other wooden ladder chair or other similar chair in the market is very expensive.
- Chair base and back are semi-finished assembly before shipping, only need to assemble the back to the base after receiving the package. It's very easy.
- And the carton size is small.

Chair size 37.8x39x94 cm

Ladder overall size 37.8x78x77 cm H · Step height 20.5 cm
N.W.: 7 KGS.



OPEN HERE TO BE A LADDER



Security lock
must lock it when
used as a chair

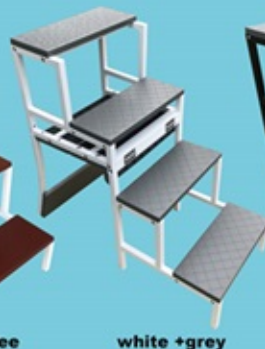

TH-2102 PATENT
RETRACTABLE WAVE
CLOTHES HANGER

page 1

Peel & Stick
Tape or Screw
Mount!

- Space Saver
- Easy to Open & Folds Away
- Compact Design

Wave
Design

Keeps clothes
evenly spaced
Stops
Bunching

OPEN

CLOSED



HOLDS
UP TO 20 LBS**



Unit Measures: 16.25" x 1.75" (Closed)

Retractable Clothes Hanger



- Space Saver
- Easy to Open & Folds Away
- Compact Design

Retractable Clothes Hanger

This wall-mounted folding rack is like having an instant closet! Simply pull open to use & just as easily folds up when not used.

The unique wave design ensures clothes are spaced & organized to avoid bunching.

Use it in the laundry room to organize your laundry and to dry clothes, or as extra hanger for guest coats, great in bedrooms, bathrooms, office, mudrooms etc. Compact & easy to install makes it perfect for dorm rooms and tight spaces.



Laundry



Entryway



Dorms/Bedrooms

**USE TWO UNITS WITH A ROD TO
CREATE EVEN MORE HANGING SPACE!**



HOLDS UP TO 20 LBS**

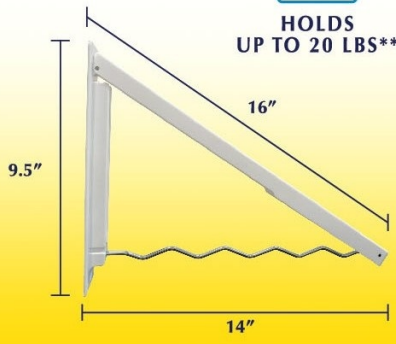

Unit Measures: 16.25" x 1.75" (Closed)

Mini Level and
Mounting Hardware
Included

UNDER CABINET JAR OPENER



**Just Peel
& Stick**

No more straining and struggling to open jars. Jar Hero's unique V will grip any lid and open it with ease! The space saving design discretely mounts under your cabinets with the included peel & stick adhesive. Easier to use than hand held openers, especially for those with weak hands or arthritis.



Great For All Sizes!

Package Includes:



3-Screws



Peel & Stick Adhesive

TH-1307

FITS FOR ALL SIZES TABLET PC /
SMART PHONE
ROUND SWIVEL STAND

Product Description:

1. Complete 360 degree swivel viewing, perfect for movie, hands-free calling or charging your device. Great for home, school, office, shop etc. use.
2. Designed to accommodate both horizontal and vertical viewing.
3. Fits any size tablets and mobile phones models.
4. Slim and durable construction.
5. Light weight small size, easy to carry and store.
size: ϕ 15x1.5-3cm(base height 1.5 cm), N.W.:156g.



Great for 12~13" Tablet.



360°



360°



TH-988

Handler of 7"~11" Tablet & Desk Mount

Product Description:

1. Support hold full size 6"-11" iPad, tablet. Easy hold with elastic ring.
2. Work as mobil hand brace and a desktop stand
3. Mobile hand brace rotates 360° from portrait to landscape
4. Mobile hand brace has a Velcro strap for stress-free holding
5. Desktop base unit swivels 360° for screen sharing
6. The Hand Brace is removable from base unit working as a hand holder.



Can change the earrings according to the Tablet Size.
Short earrings for small size, long earrings for big size.

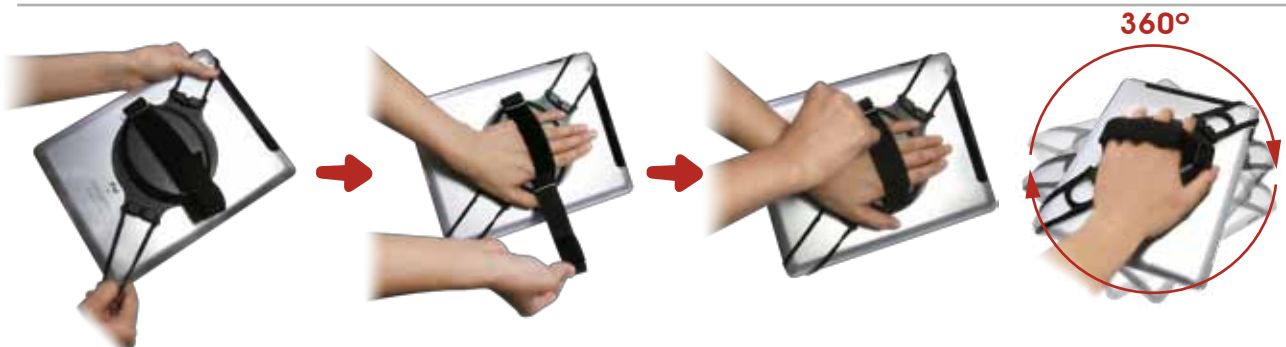

TH-1311

UNIVERSAL TABLET HOLDER HAND HOLDER & DESKTOP STAND

Product Description:

1. It can put the tablet on the stand or mount the tablet to hand for mobile using.
2. It can capture two corners of the tablet to make sure safety and security of users' device.
3. Two sets special elastic earrings support universal size Tablet.
4. Swivel 360 degrees for perfect viewing.
5. Detachable handle with Neoprene and Velcro Strap, comfortably fit all size left or right hand.
6. The handle can be separated from holding bracket, it is convenient to carry around.



TH-1711

PATENT

專利可調式鞋架

PATENT ADJUSTABLE SHOE STAND

- Easily and securely adjust to different angles by patent notched gear structure.
- With big open space fits all standard shoe sizes.
- Storage shoes easily, save about 50% space.
- Material: PP
- MADE IN TAIWAN
- 專利齒輪結構，極輕鬆調整且牢牢固定在不同角度。
- 開口空間加大，適用所有鞋款。
- 收納容易，節省約50%空間。
- 材質:PP
- 臺灣製



Airflow hole 透氣孔

L 24.5x W10 x H7~22 CM

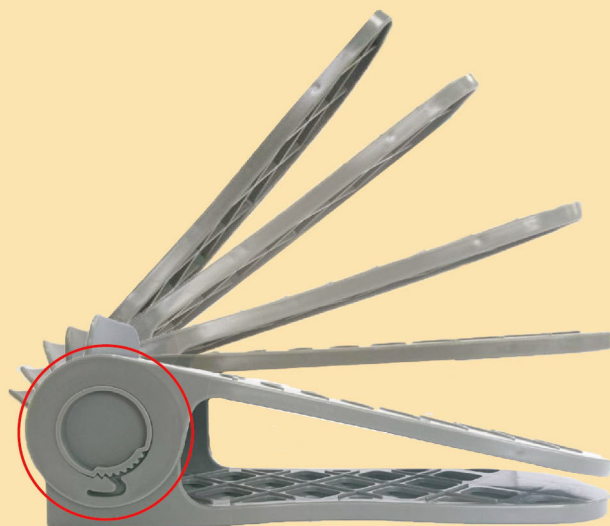

Adjust to different angles by patent notched gear structure 專利齒輪結構多角度可調



Rear anti-slip baffle. 後鞋檔設計，擋住鞋子不滑落。



Before 使用前



After 使用後

TH-1903

Bedhead Pillow Side Storage Tray

床頭枕邊收納架

PATENT
TAIWAN JAPAN
CHINA U.S.A.

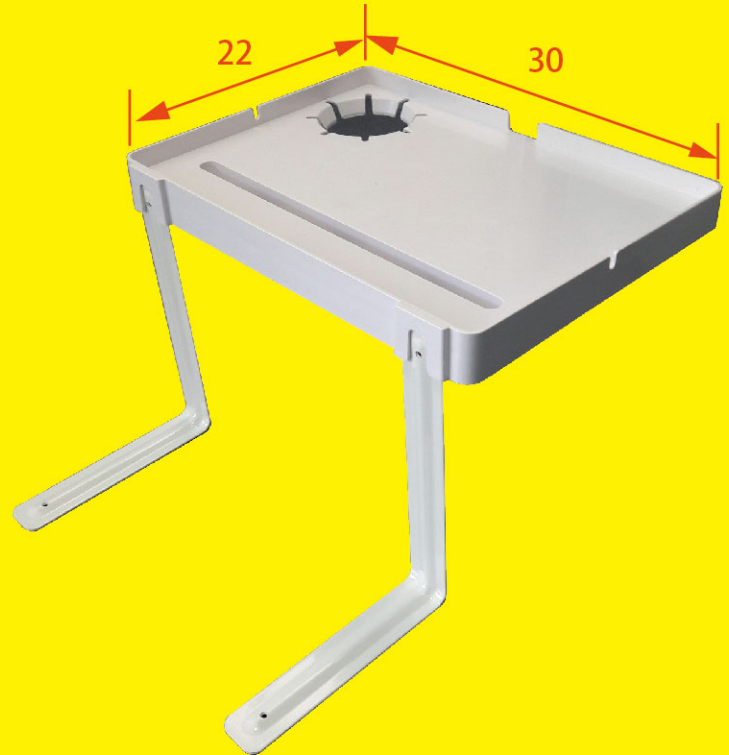

*It's the elderly people's favorite product, the children's best choice to show filial piety, the water is readily available during midnight.

*Holding phones, tablets, watches, eye glasses, headphones, remote controller, book etc.

*Put it beside the bedhead pillow, it won't affect in and out of bed.

*Easy to use and assemble without tools.

*銀髮族的最愛，兒孫的最佳孝親選擇，夜晚喝水隨手可得。

*可以放平板、手機、耳機、眼鏡、遙控器、書本等。

*放置床頭枕邊，不影響上下床。

TH-1709

Screen Top Shelf for TV & Computer

創新電視電腦
螢幕頂端置物架

PATENT
TAIWAN JAPAN
CHINA U.S.A.

- Ingenious design. Conveniently and tidily store knickknacks, office supplies, remote controller, set-top box etc.
 - ABS material, sturdy and durable. High Temperature and deformation resistance.
- Fits all size TV and Computer's screen.

- 獨特精美的設計，任何空間都不放過，超薄螢幕上也能整齊收納
- ABS材質，堅固耐用，耐高溫不變形。獨特支撐結構，安穩兼容各類型電視電腦螢幕架。



32.7cm(12.9")

Big Size

16.2cm
(6.4")



Easy to use, no tool needed. Put the shelf, adjust the angle until the shelf surface is flat, tighten the plastic nut.

使用簡單，不需工具，放上置物架，調整到架子表面水平，轉緊塑膠螺帽即可。

適合放各種物品

Can Put Any Different Items



視訊攝影機

Webcam



遊戲感應器

Game sensor



電視機上盒

Set-top box



TH-019

Multi-Functional Turning Plate



TH-019A
 Ø 40.5cm
 Load weight 100 kg
 Thickness 2 cm



TH-019B
 Ø 25cm
 Load weight 60 kg
 Thickness 2 cm



TH-019C
 Ø 32cm
 Load weight 80 kg
 Thickness 2 cm

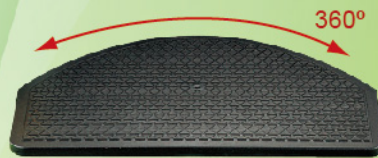

TH-019F
 L55 x W40.5cm
 Load weight 100 kg
 Thickness 2 cm

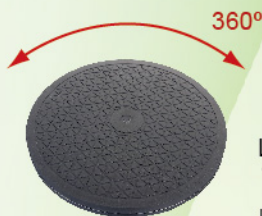

TH-019S
 Ø 20cm
 Load weight 50 kg
 Thickness 1.5 cm
 Extremely Smooth & Heavy Duty Swivel



TH-035

Swivel Seat

Swivel Seat

If you suffer back pain or partial immobility this swivel seat provides invaluable help in getting in and out of cars, chairs and beds.

The padded seat is mounted on a ball-bearing turntable that allows you to easily swing your legs out of the car or bed and swivel your entire body through 90 degrees towards the exit.

Size: Ø40.5 cm H 5 cm , Ø40.5 cm H 10 cm



Ø 40x10 cm

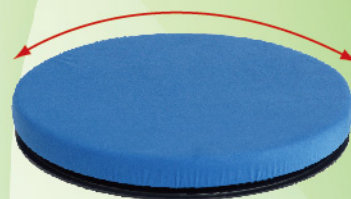

Ø 40x5 cm



Dock / Swimming Pool / Yacht Ladder 4-Steps Stainless Steel Ladder

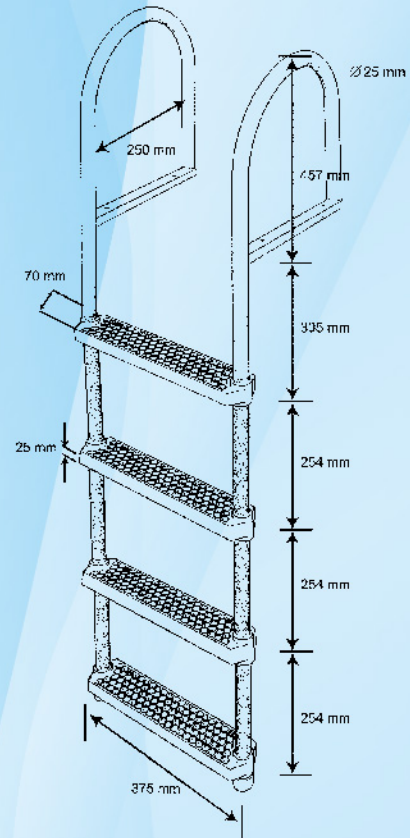

Made of stainless steel with 4 weatherproof steps made of polypropylene.

Pipe stainless steel No.#316

Screw material: Stainless Steel made#316

Plastic material: PP shock-resistance (impact PP)

Pipe size: ϕ 25mm

Length:1550mm

Nut material: Stainless Steel made #316

Maximum load: 150KGS.

Width: 375mm

Dock / Swimming Pool / Yacht Ladder 3-Steps Aluminum Ladder

Material: Aluminum Tube+PP (Hi-impact) step

Size: Dia 1" Aluminum Tube, Thickness: 1.2mm

Finishing Anodic Treatment



TH-103 Garden Partition

Item	garden partition TH-103
Specification	L:20 cm ; H:17 cm
Material	PP
Colors	green
Quantity	12 pcs / set Length:24M
Functions	plants partitions
	stop grass spreading, maintenance
Features	to be assembled for any shapes

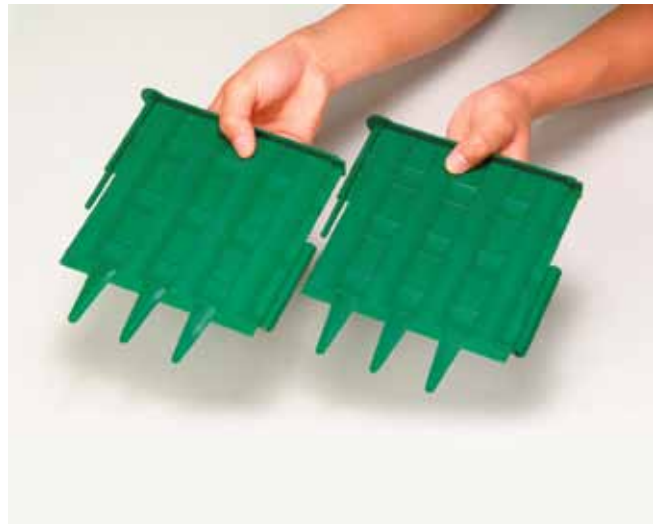

TH-029 & TH-030

Kitchen Turning Plate

Single Plate



Double Plate

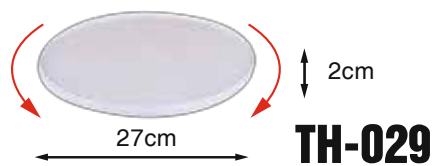

TH-156 Flat TV swivel Stand

Product Description:

1. Feature with 360 degree swivel plate at bottom, ideal for LCD/LED Monitor/ TV.
2. The lower level is suitable for DVD player, VCD or other Audio and Video equipment.
3. Saving your space and easy storage.
4. Overall size: L53xW34xH16 cm.
5. Size of the cabinet for the dvd player is 48x34x10.5CM
6. Hold up to 42 inch (LED TV)
7. Maximum weight 90KGS.



Size: L53 x W30 x H2cm



TH-156-1

TH-156-2

TH-156-3

Vertical Flute TH-008



TH-1703 Assemblable Multifunctional Working Dolly and Kitchen/Bathroom Storage Rack, Appliances Rack

組合式多功能工作臺車
廚衛收納架、電器架

PATENT
TAIWAN JAPAN
CHINA U.S.A.

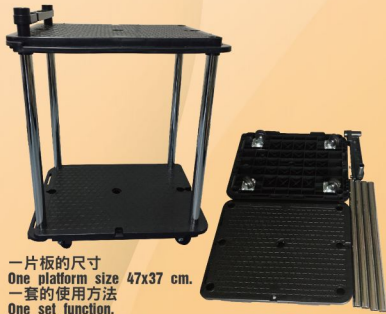

一片板的尺寸
One platform size 47x37 cm.
一套的使用方法
One set function.

一套的配件
One set components.



載重 180kgs.
Load weight 180kgs.

可搭配繩索使用
Can be easily pulled
by a random rope.



兩套的使用方法
Two sets function



三套的使用方法 Three sets function



替代昂貴的
托板車，方便
好用，移動重物，
轉彎無死角，省錢省力省時
Instead of expensive pallet
truck, easily moving heavy
cargoes 360 degree free
moving.



把手可伸縮
The handle is stretchable.



背面蜂巢式強化結構，
防止變形
With honeycomb structure
at back to avoid deformation.



不需螺絲即可正面，側
面，或正側面及上下多
層無限連結，工作臺面
大小可任意調整。

Interconnected both length
and sideways to make un-
limited larger or longer plat-
forms. Can be connected to
be two or three tier. It is
very easy to link them
without screw.